



SV9601

**Official NOTE:**

- Where the MAINS plug is used as the disconnect device, the disconnect device shall remain readily operable. In English this means; For safety reasons, please ensure that the power plug (to mains) is easily accessible (not blocked or covered) so it can be used to disconnect the device.
- Please ensure a minimum distance of 5 cm around the apparatus for sufficient ventilation.
- Please ensure that the ventilation is not impeded by covering the ventilation openings with items such as newspapers, tablecloths, curtains, etc.
- Do not place near naked flame sources, such as lighted candles.
- To reduce the risk of fire or electric shocks do not expose this apparatus to rain or moisture, dripping or splashing.
- Use the apparatus only in moderate climates (not in tropical climates).

**Guarantee English** UNIVERSAL ELECTRONICS / ONE FOR ALL warrants to the original purchaser that this product will be free from defects in materials and workmanship under normal and correct use for a period of one (1) year from the date of original purchase. This product will be repaired or if necessary replaced free of charge if it has been proven to be defective within the one (1) year warranty period. The forwarding costs are on the account of the owner; the costs of returning the product are on the account of UNIVERSAL ELECTRONICS / ONE FOR ALL.

This warranty does not cover damage or failures caused by products or services not supplied by UNIVERSAL ELECTRONICS / ONE FOR ALL, or which result from not mounting the product according to manual instructions. This also applies when the product has been modified / repaired by others than UNIVERSAL ELECTRONICS / ONE FOR ALL or if a fault is the result from accident, misuse, abuse, neglect, mishandling, misapplication, faulty installation, improper maintenance, alteration, modifications, fire, water, lightning, natural disasters, wrong use or carelessness.

To obtain warranty service during the warranty period, please notice that we need your original purchase receipt so that we may establish your eligibility for service. If you have bought this product for purposes which are not related to your trade, business or profession, please remind that you may have legal rights under your national legislation governing the sale of consumer goods. This guarantee does not affect those rights.

## We're ready to assist with the installation

**Support**

Learn about One For All products, download manuals, watch instruction videos or get in contact with our Customer Service Team for personal assistance.



**Universal Electronics BV**  
**Europe & International**  
 P.O. Box 3332  
 7500 DH, Enschede  
 The Netherlands

**SV 9601**  
**709660**  
**RDN-1061017**

**English** **Instruction Manual**

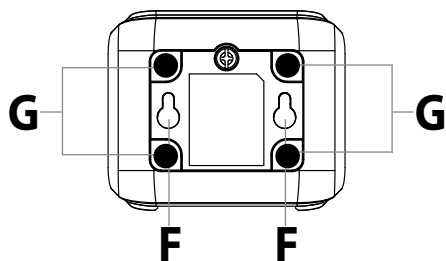
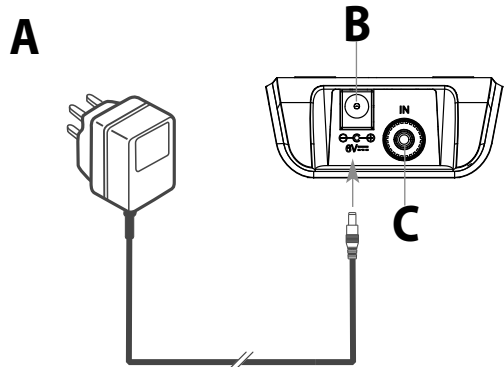
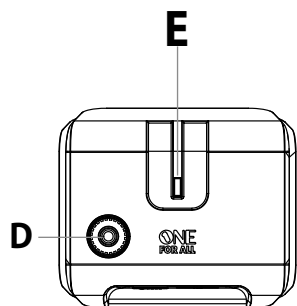
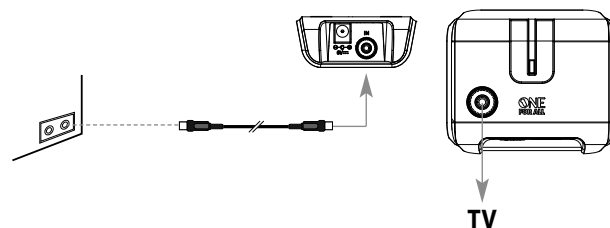
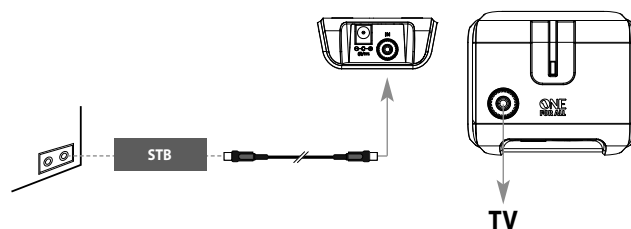
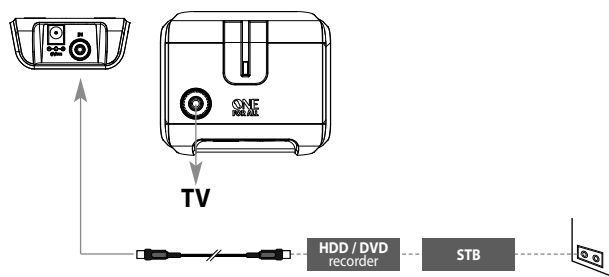
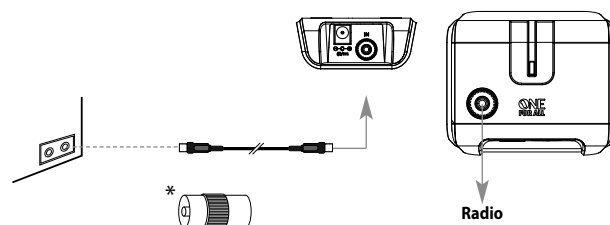

**1****2****3****4****5****THANK YOU**

Thank you for purchasing the ONE FOR ALL Signal Amplifier. ONE FOR ALL continuously strives to develop, produce and market high-quality innovative products to meet your needs. We hope this Signal Amplifier will give you total satisfaction.

**THE PRODUCT**

The ONE FOR ALL Signal Amplifier is designed to boost the signal of your cable box, this allows you to distribute the signal to multiple devices and/or use longer cables without losing picture and sound quality.

Below you'll find the description of your ONE FOR ALL Signal Amplifier (see picture 1).

- 1**
- A. Power adapter (power plug)
  - B. Power adapter input
  - C. Signal input
  - D. Signal outputs
  - E. LED indicator (ON / OFF)
  - F. Holes for wall mounting
  - G. Space for foam feet

**CONNECTING THE SIGNAL AMPLIFIER**

To connect your ONE FOR ALL Signal Amplifier, please follow the steps below:

- Stick the foam feet at the bottom of the ONE FOR ALL Signal Amplifier (G).
- Connect your TV or other device to the signal output (D)
- Connect your cable TV coaxial cable or other device (see picture 2) to the input (C) on the ONE FOR ALL Signal Amplifier.
- Plug the power adapter to the input (B) on the ONE FOR ALL Signal Amplifier.
- Plug the power adapter into the mains (A).
- Check if the LED indicator illuminates (E).

**Wall mount installation**

- You can use the holes at the back of the ONE FOR ALL Signal Amplifier for wall mount installation (F).

Examples of different situations (pictures 2 – 5):

- 2** A coaxial cable for your cable TV (DVB-C / DVB-C2) is connected to the input (IN) of the ONE FOR ALL Signal Amplifier. The signal will be boosted and distributed to 1 TV or another device.
- 3** The coaxial output of a TV receiver (DVB-C / DVB-C2) is connected to the input (IN) of the ONE FOR ALL Signal Amplifier. The signal will be boosted and distributed for 1 TV or another device.
- 4** A coaxial cable for your cable TV (DVB-C / DVB-C2) is connected to the coaxial input of a TV receiver, which is connected to the HDD / DVD recorder. The coaxial output of the HDD / DVD recorder is connected with the input (IN) of the ONE FOR ALL Signal Amplifier. The signal will be boosted and distributed to 1 TV or another device.
- 5** The FM is connected to the input (IN) of the ONE FOR ALL Signal Amplifier which will boost the signal and distribute it to 1 radio tuner.

(\*) It may be possible that you have to use inline coax-connectors to make the connections. (See picture).

**HELPFUL HINTS**

If the picture or sound quality is unsatisfactory, please follow the helpful hints below:

- If the incoming signal is unclear, the ONE FOR ALL Signal Amplifier will not improve your picture as it will also amplify the noise in the signal. Please contact your cable TV installer for further details.
- Check all the connections. Loose or bad connections will result in an unclear picture.